

JY997D29501E

MITSUBISHI
Changes for the Better

GT10-LDR Memory loader

USER'S MANUAL

Manual Number	JY997D29501E
Date	Apr. 2010

This manual describes the part names, dimensions, mounting, and specifications of the product. Before use, read this manual and manuals of relevant products fully to acquire proficiency in handling and operating the product. Make sure to learn all the product information, safety information, and precautions.
 And, store this manual in a safe place so that you can take it out and read it whenever necessary. Always forward it to the end user.
 Registration
 The company name and the product name to be described in this manual are the registered trademarks or trademarks of each company.
 Effective Apr. 2010
 Specifications are subject to change without notice.

Safety Precaution (Read these precautions before using.)
 Before using this product, please read this manual and the relevant manuals introduced in this manual carefully and pay full attention to safety to handle the product correctly.
 The precautions given in this manual are concerned with this product. In this manual, the safety precautions are ranked as "DANGER" and "CAUTION".

	Indicates that incorrect handling may cause hazardous conditions, resulting in death or severe injury.
	Indicates that incorrect handling may cause hazardous conditions, resulting in medium or slight personal injury or physical damage.

Depending on circumstances, procedures indicated by "CAUTION" may also be linked to serious results.
 In any case, it is important to follow the directions for usage.

MOUNTING PRECAUTIONS

- Use the memory loader in the environment that satisfies the general specifications described in GT10 User's manual. Never use the product in areas with excessive dust, oily smoke, conductive dusts, corrosive gas (salt air, Cl₂, H₂S, SO₂ or NO₂), flammable gas, vibration or impacts, or exposed to high temperature, condensation, or rain and wind. Not doing so can cause an electric shock, fire, malfunction or product damage or deterioration.

STARTUP/MAINTENANCE PRECAUTIONS

- Do not disassemble or modify the memory loader. Doing so can cause a failure, malfunction, injury or fire.
- Do not touch the conductive and electronic parts of the memory loader directly. Doing so can cause a memory loader malfunction or failure.
- When unplugging the cable connected to the GOT, do not hold and pull the cable portion. Doing so can cause the memory loader or cable to be damaged or can cause a malfunction due to a cable connection fault.
- Do not bent at a sharp angle or tie the memory loader cables. Doing so can cause the breaking of the cables.

DISPOSAL PRECAUTIONS

- When disposing of the product, handle it as industrial waste.

TRANSPORTATION PRECAUTIONS

- Make sure to transport the memory loader and/or relevant unit(s) in the manner they will not be exposed to the impact exceeding the impact resistance described in the general specifications of this manual, as they are precision devices. Failure to do so may cause the unit to fail.

Compliance with EC directive (CE Marking)
 This note does not guarantee that an entire mechanical module produced in compliance with the contents of this note will comply with the following standards. Compliance to EMC directive for the entire mechanical module should be checked by the user / manufacturer. For more details please contact the local Mitsubishi Electric sales site.

Attention

- This product is designed for use in industrial applications.
- Manufactured by: Mitsubishi Electric Corporation
2-7-3 Marunouchi, Chiyoda-ku, Tokyo 100-8310 Japan
- Manufactured at: Mitsubishi Electric Corporation Himeji Works
840 Chiyoda-machi, Himeji, Hyogo 670-8677 Japan
- Authorized Representative in the European Community:
Mitsubishi Electric Europe B.V.
Gothaer Str. 8, 40880 Ratingen, Germany.

Requirement for Compliance with EMC directive
 The following products have shown compliance through direct testing (to the identified standards) and design analysis (forming a technical construction file) to the European Directive for Electromagnetic Compatibility (2004/108/EC) when used as directed by the appropriate documentation.
 Type :Programmable Controller (Open Type Equipment)

Standard	EMI	EMS	Remark
EN61131-2 : 2007 Programmable controllers- Equipment, requirement and tests	EMI		Compliance with all relevant aspects of the standard. (Radiated Emissions)
		EMS	Compliance with all relevant aspects of the standard. (ESD, RF electromagnetic field, EFTB, Surge, RF conducted disturbances and Power frequency magnetic field)

For more details please contact the local Mitsubishi Electric sales site.

Associated Manuals
 The following manuals are relevant to this product. When these loose manuals are required, please consult with our local distributor.

Manual name	Contents	Manual Number (Model Code)
GT10 User's Manual	Describes the GT10 hardware-relevant content such as part names, external dimensions, mounting, power supply wiring, specifications, and introduction to option devices. (sold separately)	JY997D24701 (09R819)
GT Designer2 Version2 Basic Operation/Data Transfer Manual (For GOT1000 Series)	Describes methods of the GT Designer2 installation operation, basic operation for drawing and transmitting data to GOT1000 series (sold separately)	SH-080529ENG (1D7M24)
GT Designer3 Version1 Screen Design Manual (For GOT1000 Series) (Fundamentals)	Describes methods of the GT Designer3 installation operation, basic operation for drawing and transmitting data to GOT1000 series (sold separately)	SH-080866ENG (1D7MB9)

Bundled item	Quantity
GT10-LDR memory loader	1
USB cable (1m)	1
GT10-LDR Memory loader USER'S MANUAL (This manual)	1

1. Overview
 GT10-LDR memory loader is the memory transfer module that reads/writes the data to GT10 or between a PC (GT Designer2 Ver.2.77F or later, GT Designer3 Ver.1.01B or later) and GT10-LDR.

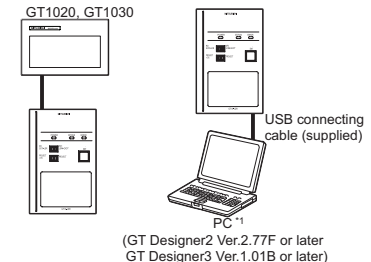

*1 When GT10-LDR is connected to a PC via the USB hub, the power supply of the USB hub must be supplied by the AC adapter of the USB hub. GT10-LDR connected to the USB hub may not work properly depending on the PC environment. In the case, connect the GT10-LDR directly to the USB port on the PC.

2. Specifications
2.1 General Specifications

Item	Specifications																	
Operating ambient temperature	0 to 40°C																	
Storage ambient temperature	-20 to 60°C																	
Operating ambient humidity*1	10 to 90% RH, non-condensing																	
Storage ambient humidity*1	10 to 90% RH, non-condensing																	
Vibration resistance	<table border="1" style="width: 100%; border-collapse: collapse;"> <thead> <tr> <th style="width: 20%;">Frequency</th> <th style="width: 20%;">Acceleration</th> <th style="width: 20%;">Half-amplitude</th> <th style="width: 40%;">Sweep Count</th> </tr> </thead> <tbody> <tr> <td>5 to 9Hz</td> <td>--</td> <td>3.5mm</td> <td rowspan="4">10 times each in X, Y and Z directions</td> </tr> <tr> <td>9 to 150Hz</td> <td>9.8m/s²</td> <td>--</td> </tr> <tr> <td>5 to 9Hz</td> <td>--</td> <td>1.75mm</td> </tr> <tr> <td>9 to 150Hz</td> <td>4.9m/s²</td> <td>--</td> </tr> </tbody> </table>	Frequency	Acceleration	Half-amplitude	Sweep Count	5 to 9Hz	--	3.5mm	10 times each in X, Y and Z directions	9 to 150Hz	9.8m/s ²	--	5 to 9Hz	--	1.75mm	9 to 150Hz	4.9m/s ²	--
	Frequency	Acceleration	Half-amplitude	Sweep Count														
	5 to 9Hz	--	3.5mm	10 times each in X, Y and Z directions														
	9 to 150Hz	9.8m/s ²	--															
5 to 9Hz	--	1.75mm																
9 to 150Hz	4.9m/s ²	--																
Shock resistance	Conforms to JIS B3502, IEC 61131-2 (147 m/s ² , 3 times each in X, Y and Z directions)																	
Operating atmosphere	Must be free of lamp black, corrosive gas, flammable gas, or excessive amount of electro conductive dust particles and must be no direct sunlight. (Same as for saving)																	
Operating altitude*2	2000 m (6562 ft) max.																	
Overvoltage category*3	II or less																	
Pollution degree*4	2 or less																	
Cooling method	Self-cooling																	

*1 The wet bulb temperature is 39°C or less.
 *2 Do not use or store the GOT under pressure higher than the atmospheric pressure of altitude 0m (0ft.). Failure to observe this instruction may cause a malfunction. When the air inside the control panel is purged by pressurization, the surface sheet may be pulled by high pressure. As a result, the touch panel may be difficult to press, and the sheet may be peeled off.
 *3 This indicates the section of the power supply to which the equipment is assumed to be connected between the public electrical power distribution network and the machinery within the premises. Category II applies to equipment for which electrical power is supplied from fixed facilities. The surge voltage withstand level for up to the rated voltage of 300 V is 2500 V.
 *4 This index indicates the degree to which conductive material is generated in the environment where the equipment is used. In pollution degree 2, only non-conductive pollution occurs but temporary conductivity may be produced due to condensation.

2.2 Performance Specifications

Item	Specifications	
Memory	User memory*1	
	Flash ROM 7.5Mbyte	
Life (Number of write times)	100,000 times	
LED	POWER	green
	SET/RUN	green/red/orange
	ERROR	green/red/orange

Item	Specifications	
Switch	RD/WR selection switch	Paddle switch
	Data selection switch	
	ENT key	Tactile switch The use of 100 thousand times is due for replacement. (operating force 2.55N ± 0.69N)
	Write protection switch	Slide switch
External dimensions	W70(2.75)×H110(4.33)×D21(0.82)[mm](inch)	
Weight	0.2kg	

*1 ROM in which new data can be written without deleting the written data.

2.3 Communication Specifications

Item	Specifications
GOT communication	Conforming to RS232 Transmission speed :115,200bps Connector shape : MINI DIN 6Pins (Male)
PC communication	Conforms to USB2.0 (Full speed is supported.) (Performs the conversion between USB and serial in GT10-LDR. After serial conversion, transmission speed is 115,200bps.) Connector shape :USB MINI-B 5Pins (Receptacle)

3. External Dimensions

External Dimensions

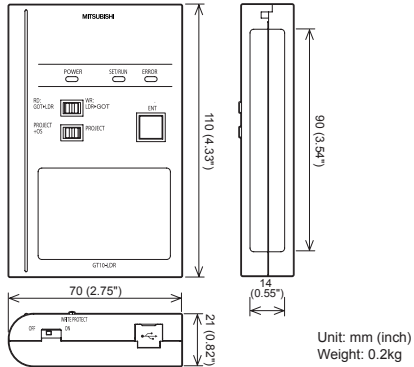

2.4 Power Supply Specifications

Item	Specifications
Input power supply voltage	DC5V (DC4.75 to 5.25V) Supplied from the GOT or PC (Supplied from bus power)
Fuse	-
Power consumption	0.7W (140mA/DC5V) or less

Cable length

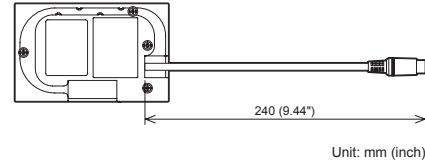

4. Part Name

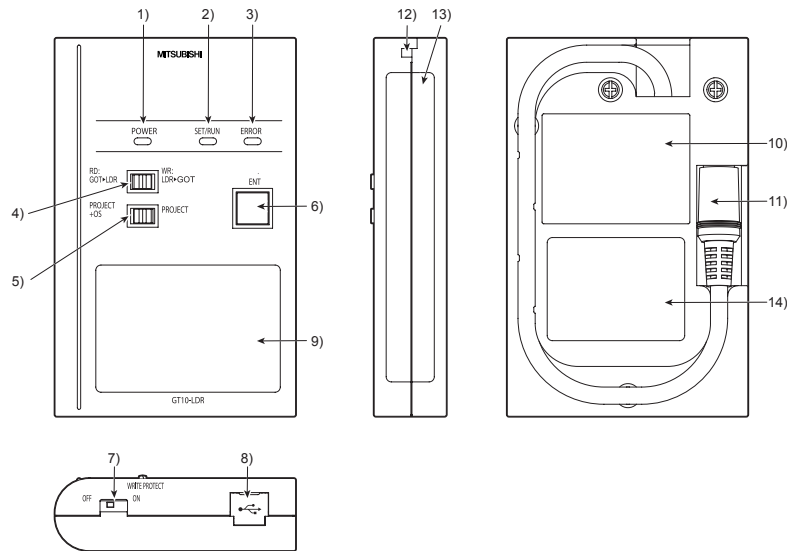

No.	Name	Specifications
1)	POWER LED	LED to show power status
2)	SET/RUN LED	LED to show that the settings are being checked/the transfer is running
3)	ERROR LED	LED to show error status
4)	RD/WR selection switch	Switch to select read/write direction
5)	Data selection switch	Switch to select the data to be transferred
6)	ENT key	Switch to determine the transfer direction and the data to be transferred, and to start the transfer

No.	Name	Specifications
7)	Write protection switch	Switch to prevent the memory loader from being written to the data
8)	USB port	Connection port with a PC (with protection cap)
9)	Reference plate (operating instructions)	Described operating instructions of the memory loader
10)	Reference plate (error contents)	Described lighting status of ERROR LED
11)	Transfer cable	Cable to be connected with the GOT
12)	Strap hole	A hole to attach a strap
13)	Part to be labeled	Space to be labeled (created by user)
14)	Rating plate (Nameplate)	--

5. LED lighting specification

LED Name	Status	Contents
POWER	POWER LED is lit.	Power is supplied.
	POWER LED is not lit.	Power is not supplied.
SET/RUN	POWER LED is not lit.	Before starting the transfer.
	Orange light	The transfer direction and the data to be transferred are determined.
	Green flashing	The transfer is running.
	Green light	The transfer is completed.
	Red flashing	The transfer is aborted.
ERROR	POWER LED is not lit.	No errors
	Green light*1	Write protection switch ON
	Green flashing*1	The GOT type that is set in the data to be transferred differs from that of the GOT to which the data is transferred.
	Red light*1	The data to be transferred is broken. The major version of the standard monitor OS is different from that of the project data.
	Red flashing*1	Communication error occurs between the GOT and the memory loader.
	Red ⇄ Green*1	Password is set in the project data.
	Orange ⇄ Green*1	OS installation screen is not active

*1 An error message appears on the GOT screen. Apply remedies according to the display. Refer to the "Chapter 12 Troubleshooting" for details on handling errors.

6. Switch operation specification

Switch Name	Specifications
RD/WR selection switch	Switch to select read/write direction RD : The data is read out from the GOT to the memory loader. WR : The data is written from the memory loader to the GOT.
Data selection switch	Switch to select the data to be transferred • When reading out the data from the GOT to the memory loader [PROJECT + OS] : The standard monitor OS, communication driver, project data, and resource data are read out from the GOT to the memory loader. [PROJECT] : The project data and resource data are read out from the GOT to the memory loader. • When writing the data from the memory loader to the GOT [PROJECT + OS] : The standard monitor OS, font data, communication driver, and project data are written from the memory loader to the GOT. [PROJECT] : The project data is written from the memory loader to the GOT.
Write protection switch	Switch to prevent the memory loader from being written to the data ON : The data cannot be written neither from the GOT or a PC (GT Designer2, GT Designer3) to the memory loader. OFF : The data can be written from the GOT or a PC (GT Designer2, GT Designer3) to the memory loader.
ENT key	Switch to determine the transfer direction and the data to be transferred, and to start the transfer The transfer starts by pressing the key twice. • The first pressing of the key determines the read/write direction and the data to be transferred. (After the read/write direction and the data to be transferred are determined, if RD/WR selection switch and Data selection switch are operated, the operations that have been made will be canceled.) (The ENT key must be pressed within 30 seconds after the first pressing of the ENT key. Failure to do so cancels the operations that have been made.) • The second pressing of the key starts the transfer.

*1 When the standard monitor OS and communication driver are transferred from the memory loader to the GOT, starting up the GOT with OS installation screen is required.

7. Function specification

7.1 Transfer function

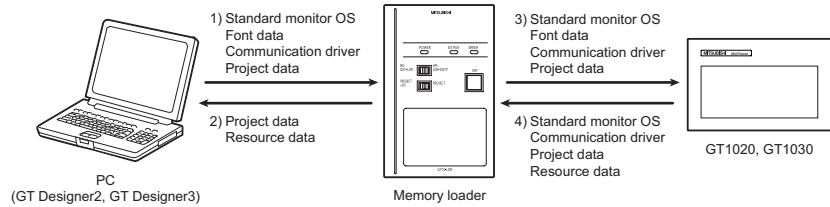

○ : Available to transfer × : Unavailable to transfer

Transfer direction	Data selection switch	Transfer data					Operation
		Project data	Resource data	Standard monitor OS	Font data*2	Communication driver	
1) PC → Memory loader	--	○	×	○	○*3	○	After all data in the memory loader is deleted, the data selected with GT Designer2 or GT Designer3 is written to the memory loader all at once.
2) Memory loader → PC	--	○	○	×	×	×	The project data or resource data is read out from the memory loader to a PC.
3) Memory loader → GOT	PROJECT + OS	○	×	○	○*4	○	All data in the memory loader is written to the GOT.
	PROJECT	○	×	×	×	×	Only the project data in the memory loader is written to the GOT.
4) GOT → Memory loader	PROJECT + OS*1	○	○	○	×	○	After all data in the memory loader is deleted, all data in the GOT is read out to the memory loader.
	PROJECT	○	○	×	×	×	After all data in the memory loader is deleted, only the project data and resource data in the GOT are read out to the memory loader.

- *1 Ver.01.08.00 or later of the standard monitor OS of the GT10 is applicable.
 *2 Ver.01.11.00 or later of the standard monitor OS of the GT10 is applicable.
 *3 Ver. 2.91V or later of GT Designer2 or Ver. 1.01B or later of GT Designer3 are applicable.

- *4 It takes longer time to transfer the font data than to transfer the standard monitor OS and communication driver. (It takes approximately 1 minute and 45 seconds to transfer "Standard monitor OS + Communication driver". It takes approximately 8 minutes to transfer "Standard monitor OS + Communication driver + Font data".) Japanese (supporting Europe) is installed in the GT10 before shipment from the factory. It is not necessary to transfer the font data when the used font is not changed.

7.2 Password reset function on the GOT

When reading out the project data from the memory loader, if the password is set in the project data, password entry screen will appear on the GOT. After entering the password, password is reset by pressing the ENT key on the screen. The data will be transferred from the GOT to the memory loader. The operation procedure is described below. When this function is used, Ver.01.08.00 or later of the standard monitor OS of the GT10 is required.

- 1) When the upload is started, password entry screen will appear on the GOT. Touch the "INPUT" key.

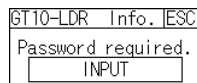

- 2) After inputting password, touch the "ENT" key.

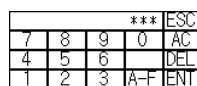

- 3) When the password matches, a message notifying Password correct is display. Touch the [ESC] button to close the screen.

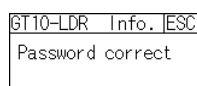

When the password does not match, an error message is displayed. If [OK] button is touch it returns to the password input screen again.



7.3 Error display function

If an error occurs between the GOT and the memory loader during the transfer, an error message will appear on the GOT screen. Apply remedies according to the display.

Chapter 12 Troubleshooting
 Turning OFF and ON the power or touching the screen will close the error message screen. When this function is used, Ver.01.08.00 or later of the standard monitor OS of the GT10 is required.

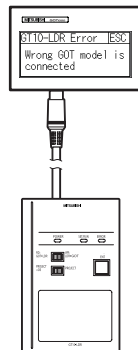

Error message on the GOT

8. Installation of Driver, Setting Software

When the communication between a PC (GT Designer2 Ver.2.77F or later, GT Designer3 Ver.1.01B or later) and the memory loader is performed, driver installation, communication port setting is required.

8.1 Driver installation

When the communication between a PC (GT Designer2, GT Designer3) and the memory loader is performed, driver installation is required. Refer to the following manual for details about driver installation.

GT Designer2 Version □ Basic Operation/Data Transfer Manual
 GT Designer3 Version □ Screen Design Manual (Fundamentals)

8.2 Confirmation of communication port

Windows® XP example follows.

- In Windows® XP, click [Start] → [Settings] → [Control Panel] → [Performance and Maintenance] → [System] → [Hardware] → [Device Manager (D)] and the window below will be displayed. Please confirm the COM number to which the USB driver is allocated (COM and LPT).
- If using Windows® 98, Windows® 98SE, Windows® Millennium Edition or Windows® 2000
 A screen that is equivalent to the one below is displayed by clicking [My Computer] → [Control Panel] → [System] → [Device Manager] in the menu of the personal computer.
- If using Windows® Vista. A screen that is equivalent to the one below is displayed by clicking [Start] → [Control Panel] → [Device Manager] in the menu of the personal computer.

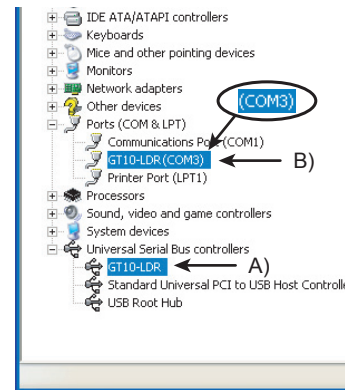

Check following:

- GT10-LDR is indicated at A).
 - GT10-LDR (COM *) is indicated at B).
 - * indicates the COM number used in Memory loader.
 - Install the GT Designer2 or GT Designer3 again when ! is displayed.
- Select the GT Designer2 or GT Designer3 COM number as the COM number currently assigned on the screen above.

8.3 Setting GT Designer2

Click [Communication] → [Communicate with GT10-LDR] → [Communication configuration tab]. Select the same COM number as the COM number of the personal computer when the setting communication port screen appears. Click [Update].

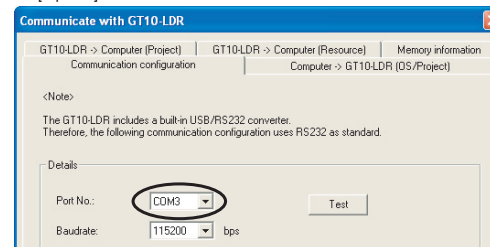

8.4 Setting GT Designer3

Click [Communication] → [Communicate with GT10-LDR...] to display the communicate with GT10-LDR screen. Click the [Communication Configuration...] tab to display the communication configuration dialog. Select the same COM number as the COM number of the personal computer when the setting communication port screen appears. Click [OK].

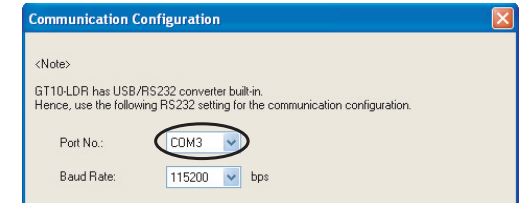

9. Transfer procedures between a PC and the Memory loader

9.1 To write the data from a PC (GT Designer2 Ver.2.77F or later, GT Designer3 Ver.1.01B or later) to the memory loader

The standard monitor OS, communication driver, font data, and project data are written from a PC (GT Designer2, GT Designer3) to the memory loader. The operation procedure is described below.

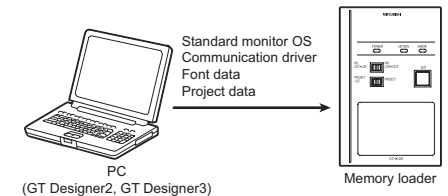

- Turn OFF the Write protection switch.
- Connect a PC (GT Designer2, GT Designer3) to the memory loader with USB cable supplied.
- Write the data from a PC (GT Designer2, GT Designer3) to the memory loader.

Refer to the following manual for details about operating instructions of GT Designer2 or GT Designer3.

GT Designer2 Version □ Basic Operation/Data Transfer Manual
 GT Designer3 Version □ Screen Design Manual (Fundamentals)

9.2 To read out the data from the memory loader to a PC (GT Designer2 Ver.2.77F or later, GT Designer3 Ver.1.01B or later).

The project data and resource data are read out from the memory loader to a PC (GT Designer2, GT Designer3). The operation procedure is described below.

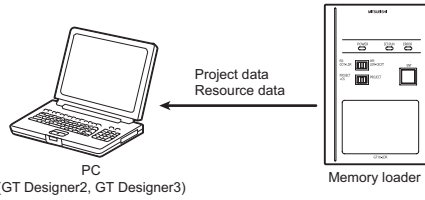

- 1) Connect a PC (GT Designer2, GT Designer3) to the memory loader with USB cable supplied.
- 2) Select the data to be uploaded in a PC (GT Designer2, GT Designer3) and read it out from the memory loader.

Refer to the following manual for details about operating instructions of GT Designer2 or GT Designer3.

GT Designer2 Version □ Basic Operation/Data Transfer Manual
 GT Designer3 Version □ Screen Design Manual (Fundamentals)

10. To write the data from the Memory loader to the GOT

The standard monitor OS, communication driver, font data, and project data are written from the memory loader to the GOT. The operation procedure is described below.

10.1 When the Data selection switch is [PROJECT + OS]

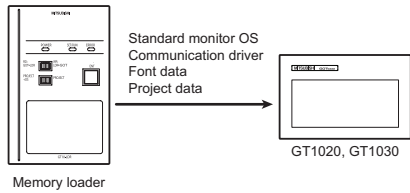

- 1) Connect the memory loader to the GOT.
- 2) Turn ON the GOT by pressing the lower right corner of the GOT.
(The GOT startups with OS installation screen.)
The OS can be transferred from GT Designer2 Version2 or GT Designer3 Version □ without displaying the OS installation screen depending on the combination of the GOT and the standard monitor OS.
Refer to the following manual for details about OS installation screen.
 GT10 User's Manual
- 3) Set the Data selection switch to [PROJECT + OS] and the RD/WR selection switch to [WR], and select the data to be transferred and transfer direction.
- 4) Press the ENT key to determine the data to be transferred and transfer direction. (SET/RUN LED will be orange.)
*: If the next operation is not performed within 30 seconds after the ENT key is pressed, SET/RUN LED will be unlit, and the operations that have been made will be canceled.
*: When the Data selection switch or the RD/WR selection switch is operated, after the data to be transferred and the transfer direction are determined, the operations that have been made will be canceled.
- 5) Press the ENT key again to start the transfer. (SET/RUN LED will be green flashing.)
- 6) Turn OFF the GOT and remove the memory loader after the transfer is completed. (SET/RUN LED will be green flashing.)

Refer to the "Chapter 12 Troubleshooting" for details on handling errors during transferring.

10.2 When the Data selection switch is [PROJECT]

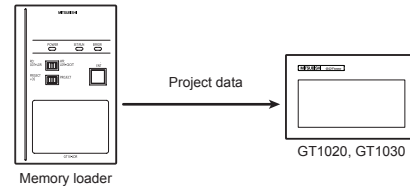

- 1) Connect the memory loader to the GOT and turn ON the GOT.
- 2) Set the Data selection switch to [PROJECT] and the RD/WR selection switch to [WR], and select the data to be transferred and transfer direction.
- 3) Press the ENT key to determine the data to be transferred and transfer direction. (SET/RUN LED will be orange.)
*: If the next operation is not performed within 30 seconds after the ENT key is pressed, SET/RUN LED will be unlit, and the operations that have been made will be canceled.
*: When the Data selection switch or the RD/WR selection switch is operated, after the data to be transferred and the transfer direction are determined, the operations that have been made will be canceled.
- 4) Press the ENT key again to start the transfer. (SET/RUN LED will be green flashing.)
- 5) Turn OFF the GOT and remove the memory loader after the transfer is completed. (SET/RUN LED will be green flashing.)

Refer to the "Chapter 12 Troubleshooting" for details on handling errors during transferring.

11. To read out the data from the GOT to the Memory loader

The standard monitor OS, communication driver, project data, and resource data are read out from the GOT to the memory loader. The operation procedure is described below.

11.1 When the Data selection switch is [PROJECT + OS]

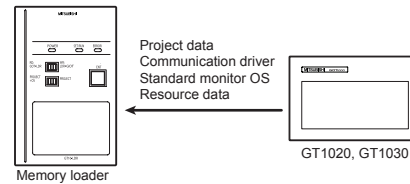

- 1) Turn OFF the Write protection switch.
- 2) Connect the memory loader to the GOT and turn ON the GOT.
- 3) Set the Data selection switch to [PROJECT + OS] and the RD/WR selection switch to [RD], and select the data to be transferred and transfer direction.
- 4) Press the ENT key to determine the data to be transferred and transfer direction. (SET/RUN LED will be orange.)
*: If the next operation is not performed within 30 seconds after the ENT key is pressed, SET/RUN LED will be unlit, and the operations that have been made will be canceled.
*: When the Data selection switch or the RD/WR selection switch is operated, after the data to be transferred and the transfer direction are determined, the operations that have been made will be canceled.
- 5) Press the ENT key again to start the transfer. (SET/RUN LED will be green flashing.)
- 6) Turn OFF the GOT and remove the memory loader after the transfer is completed. (SET/RUN LED will be green flashing.)

Refer to the "Chapter 12 Troubleshooting" for details on handling errors during transferring.

11.2 When the Data selection switch is [PROJECT]

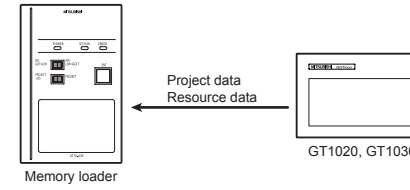

- 1) Turn OFF the Write protection switch.
- 2) Connect the memory loader to the GOT and turn ON the GOT.
- 3) Set the Data selection switch to [PROJECT] and the RD/WR selection switch to [RD], and select the data to be transferred and transfer direction.
- 4) Press the ENT key to determine the data to be transferred and transfer direction. (SET/RUN LED will be orange.)
*: If the next operation is not performed within 30 seconds after the ENT key is pressed, SET/RUN LED will be unlit, and the operations that have been made will be canceled.
*: When the Data selection switch or the RD/WR selection switch is operated, after the data to be transferred and the transfer direction are determined, the operations that have been made will be canceled.
- 5) Press the ENT key again to start the transfer. (SET/RUN LED will be green flashing.)
- 6) Turn OFF the GOT and remove the memory loader after the transfer is completed. (SET/RUN LED will be green flashing.)

Refer to the "Chapter 12 Troubleshooting" for details on handling errors during transferring.

12. Troubleshooting

12.1 GOT error message

When communication between the GOT and the memory loader does not work, check the following contents depending on the GOT error messages.

GOT error message	Remedy
Write protection switch is ON	Write protection switch ON Turn OFF the Write protection switch.
Wrong GOT model is connected	The GOT type that is set in the data to be transferred differs from that of the GOT to which the data is transferred. Check the GOT type to which the memory loader is connected.
Corrupt data or OS version variance	The data to be transferred is broken, or the major version of the standard monitor OS is different from that of the project data. <ul style="list-style-type: none"> • Write the standard monitor OS, communication driver, and project data from GT Designer2 or GT Designer3 to the memory loader again, and then transfer them to the GOT again. • Set the Data selection switch to [PROJECT + OS] and read out all data from the GOT to the memory loader, and then transfer them to the GOT again.
Communication error	Communication error occurs between the GOT and the memory loader. <ul style="list-style-type: none"> • Check the connection with the communication cable. • Check that power supply is stable. (lighting of POWER LED)
GOT contains a system password	Password is set in the project data. Reset the password with the numeric keypad on the GOT.
OS installation screen isn't active	OS installation screen is not active Install the data after the OS installation screen is displayed on the GOT.

12.2 LED display on the memory loader

If communication cannot be established between the GOT and a PC using memory loader, confirm the following status by checking display LED in memory loader.

State of POWER LED	Contents
POWER LED is lit.	The DC5V power supply from the GOT or the personal computer is normally supplied. In case of no communication, check the status of ERROR LED.
POWER LED is not lit.	The DC 5V power supply from the GOT or the personal computer is not supplied. Check the items below. <ul style="list-style-type: none"> • Turn ON the power. • Check the connection with the USB cable. • Check the connection with the GOT. • Check that PLC is not overloaded when PLC supplies the power to the GOT connected to the memory loader.

State of ERROR LED	Contents
Green light	Write protection switch ON Turn OFF the Write protection switch.
Green flashing	The GOT type that is set in the data to be transferred differs from that of the GOT to which the data is transferred. Check the GOT type to which the memory loader is connected.
Red light	The data to be transferred is broken, or the major version of the standard monitor OS is different from that of the project data. <ul style="list-style-type: none"> • Write the standard monitor OS, communication driver, and project data from GT Designer2 or GT Designer3 to the memory loader again, and then transfer them to the GOT again. • Set the Data selection switch to [PROJECT + OS] and read out all data from the GOT to the memory loader, and then transfer them to the GOT again.
Red flashing	Communication error occurs between the GOT and the memory loader. <ul style="list-style-type: none"> • Check the connection with the communication cable. • Check that power supply is stable. (lighting of POWER LED)
Red ↔ Green	Password is set in the project data. Reset the password with the numeric keypad on the GOT.
Orange ↔ Green	OS installation screen is not active Install the data after the OS installation screen is displayed on the GOT.

This manual confers no industrial property rights or any rights of any other kind, nor does it confer any patent licenses. Mitsubishi Electric Corporation cannot be held responsible for any problems involving industrial property rights which may occur as a result of using the contents noted in this manual.

Warranty

Mitsubishi will not be held liable for damage caused by factors found not to be the cause of Mitsubishi; opportunity loss or lost profits caused by faults in the Mitsubishi products; damage, secondary damage, accident compensation caused by special factors unpredictable by Mitsubishi; damages to products other than Mitsubishi products; and to other duties.

For safe use

- This product has been manufactured as a general-purpose part for general industries, and has not been designed or manufactured to be incorporated in a device or system used in purposes related to human life.
- Before using the product for special purposes such as nuclear power, electric power, aerospace, medicine or passenger movement vehicles, consult with Mitsubishi Electric.
- This product has been manufactured under strict quality control. However when installing the product where major accidents or losses could occur if the product fails, install appropriate backup or failsafe functions in the system.

MITSUBISHI ELECTRIC CORPORATION

HEAD OFFICE : TOKYO BUILDING, 2-7-3 MARUNOUCHI, CHIYODA-KU, TOKYO 100-8310, JAPAN

HIMEJI WORKS : 840, CHIYODA CHO, HIMEJI, JAPAN

JY997D29501E

MITSUBISHI *Changes for the Better*

GT10-LDR Memory loader

USER'S MANUAL

Manual Number	JY997D29501E
Date	Apr. 2010

This manual describes the part names, dimensions, mounting, and specifications of the product. Before use, read this manual and manuals of relevant products fully to acquire proficiency in handling and operating the product. Make sure to learn all the product information, safety information, and precautions. And, store this manual in a safe place so that you can take it out and read it whenever necessary. Always forward it to the end user.

Registration
The company name and the product name to be described in this manual are the registered trademarks or trademarks of each company.

Effective Apr. 2010
Specifications are subject to change without notice.

Safety Precaution (Read these precautions before using.)
Before using this product, please read this manual and the relevant manuals introduced in this manual carefully and pay full attention to safety to handle the product correctly.
The precautions given in this manual are concerned with this product.
In this manual, the safety precautions are ranked as "DANGER" and "CAUTION".

DANGER	Indicates that incorrect handling may cause hazardous conditions, resulting in death or severe injury.
CAUTION	Indicates that incorrect handling may cause hazardous conditions, resulting in medium or slight personal injury or physical damage.

Depending on circumstances, procedures indicated by "CAUTION" may also be linked to serious results.
In any case, it is important to follow the directions for usage.

MOUNTING PRECAUTIONS **CAUTION**

- Use the memory loader in the environment that satisfies the general specifications described in GT10 User's manual. Never use the product in areas with excessive dust, oily smoke, conductive dusts, corrosive gas (salt air, Cl₂, H₂S, SO₂ or NO₂), flammable gas, vibration or impacts, or exposed to high temperature, condensation, or rain and wind. Not doing so can cause an electric shock, fire, malfunction or product damage or deterioration.

STARTUP/MAINTENANCE PRECAUTIONS **CAUTION**

- Do not disassemble or modify the memory loader. Doing so can cause a failure, malfunction, injury or fire.
- Do not touch the conductive and electronic parts of the memory loader directly. Doing so can cause a memory loader malfunction or failure.
- When unplugging the cable connected to the GOT, do not hold and pull the cable portion. Doing so can cause the memory loader or cable to be damaged or can cause a malfunction due to a cable connection fault.
- Do not bent at a sharp angle or tie the memory loader cables. Doing so can cause the breaking of the cables.

DISPOSAL PRECAUTIONS **CAUTION**

- When disposing of the product, handle it as industrial waste.

TRANSPORTATION PRECAUTIONS **CAUTION**

- Make sure to transport the memory loader and/or relevant unit(s) in the manner they will not be exposed to the impact exceeding the impact resistance described in the general specifications of this manual, as they are precision devices. Failure to do so may cause the unit to fail.

Compliance with EC directive (CE Marking)
This note does not guarantee that an entire mechanical module produced in accordance with the contents of this note will comply with the following standards. Compliance to EMC directive for the entire mechanical module should be checked by the user / manufacturer. For more details please contact the local Mitsubishi Electric sales site.

Attention

- This product is designed for use in industrial applications.
- Manufactured by: Mitsubishi Electric Corporation
2-7-3 Marunouchi, Chiyoda-ku, Tokyo 100-8310 Japan
- Manufactured at: Mitsubishi Electric Corporation Himeji Works
840 Chiyoda-machi, Himeji, Hyogo 670-8677 Japan
- Authorized Representative in the European Community:
Mitsubishi Electric Europe B.V.
Gothaer Str. 8, 40880 Ratingen, Germany.

Requirement for Compliance with EMC directive
The following products have shown compliance through direct testing (to the identified standards) and design analysis (forming a technical construction file) to the European Directive for Electromagnetic Compatibility (2004/108/EC) when used as directed by the appropriate documentation.
Type :Programmable Controller (Open Type Equipment)

Standard	EMI	Remark
EN61131-2 : 2007	EMC	Compliance with all relevant aspects of the standard. (Radiated Emissions)
Programmable controllers- Equipment, requirement and tests	EMS	Compliance with all relevant aspects of the standard. (ESD, RF electromagnetic field, EFTB, Surge, RF conducted disturbances and Power frequency magnetic field)

For more details please contact the local Mitsubishi Electric sales site.

Associated Manuals
The following manuals are relevant to this product. When these loose manuals are required, please consult with our local distributor.

Manual name	Contents	Manual Number (Model Code)
GT10 User's Manual	Describes the GT10 hardware-relevant content such as part names, external dimensions, mounting, power supply wiring, specifications, and introduction to option devices. (sold separately)	JY997D24701 (09R819)
GT Designer2 Version2 Basic Operation/Data Transfer Manual (For GOT1000 Series)	Describes methods of the GT Designer2 installation operation, basic operation for drawing and transmitting data to GOT1000 series (sold separately)	SH-080529ENG (1D7M24)
GT Designer3 Version1 Screen Design Manual (For GOT1000 Series) (Fundamentals)	Describes methods of the GT Designer3 installation operation, basic operation for drawing and transmitting data to GOT1000 series (sold separately)	SH-080866ENG (1D7MB9)

Bundled Items

Bundled Item	Quantity
GT10-LDR memory loader	1
USB cable (1m)	1
GT10-LDR Memory loader USER'S MANUAL (This manual)	1

1. Overview
GT10-LDR memory loader is the memory transfer module that reads/writes the data to GT10 or between a PC (GT Designer2 Ver.2.77F or later, GT Designer3 Ver.1.01B or later) and GT10-LDR.

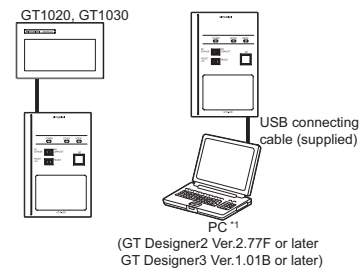

*1 When GT10-LDR is connected to a PC via the USB hub, the power supply of the USB hub must be supplied by the AC adapter of the USB hub. GT10-LDR connected to the USB hub may not work properly depending on the PC environment. In the case, connect the GT10-LDR directly to the USB port on the PC.

2. Specifications

2.1 General Specifications

Item	Specifications	
Operating ambient temperature	0 to 40°C	
Storage ambient temperature	-20 to 60°C	
Operating ambient humidity ^{*1}	10 to 90% RH, non-condensing	
Storage ambient humidity ^{*1}	10 to 90% RH, non-condensing	
Vibration resistance	Conforms to JIS B3502 and IEC61131-2	
	Under intermittent vibration	5 to 9Hz: --, 9 to 150Hz: 9.8m/s ²
	Under continuous vibration	5 to 9Hz: --, 9 to 150Hz: 4.9m/s ²
	Half-amplitude	3.5mm, 1.75mm
Sweep Count	10 times each in X, Y and Z directions	
Shock resistance	Conforms to JIS B3502, IEC 61131-2 (147 m/s ² , 3 times each in X, Y and Z directions)	
Operating atmosphere	Must be free of lamp black, corrosive gas, flammable gas, or excessive amount of electro conductive dust particles and must be no direct sunlight. (Same as for saving)	
Operating altitude ^{*2}	2000 m (6562 ft) max.	
Overvoltage category ^{*3}	II or less	
Pollution degree ^{*4}	2 or less	
Cooling method	Self-cooling	

*1 The wet bulb temperature is 39°C or less.
*2 Do not use or store the GOT under pressure higher than the atmospheric pressure of altitude 0m (0ft.). Failure to observe this instruction may cause a malfunction. When the air inside the control panel is purged by pressurization, the surface sheet may be lifted by high pressure. As a result, the touch panel may be difficult to press, and the sheet may be peeled off.
*3 This indicates the section of the power supply to which the equipment is assumed to be connected between the public electrical power distribution network and the machinery within the premises. Category II applies to equipment for which electrical power is supplied from fixed facilities. The surge voltage withstand level for up to the rated voltage of 300 V is 2500 V.
*4 This index indicates the degree to which conductive material is generated in the environment where the equipment is used. In pollution degree 2, only non-conductive pollution occurs but temporary conductivity may be produced due to condensation.

2.2 Performance Specifications

Item	Specifications	
Memory	User memory ^{*1}	Flash ROM 7.5Mbyte
	Life (Number of write times)	100,000 times
LED	POWER	green
	SET/RUN	green/red/orange
	ERROR	green/red/orange

Item	Specifications
RD/WR selection switch	Paddle switch
Data selection switch	
ENT key	Tactile switch The use of 100 thousand times is due for replacement. (operating force 2.55N ± 0.69N)
Write protection switch	Slide switch
External dimensions	W70(2.75)×H110(4.33)×D21(0.82)[mm](inch)
Weight	0.2kg

*1 ROM in which new data can be written without deleting the written data.

2.3 Communication Specifications

Item	Specifications
GOT communication	Conforming to RS232C Transmission speed :115,200bps Connector shape : MINI DIN 6Pins (Male)
PC communication	Conforms to USB2.0 (Full speed is supported.) (Performs the conversion between USB and serial in GT10-LDR. After serial conversion, transmission speed is 115,200bps.) Connector shape :USB MINI-B 5Pins (Receptacle)

2.4 Power Supply Specifications

Item	Specifications
Input power supply voltage	DC5V (DC4.75 to 5.25V) Supplied from the GOT or PC (Supplied from bus power)
Fuse	-
Power consumption	0.7W (140mA/DC5V) or less

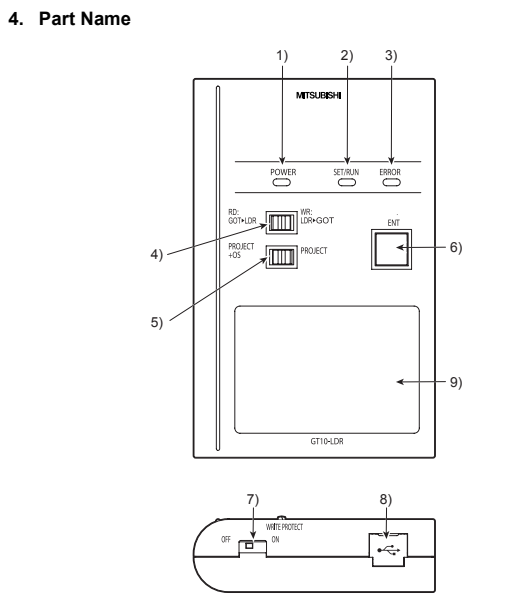
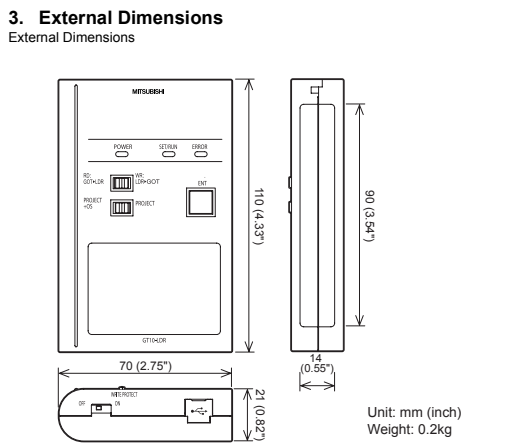
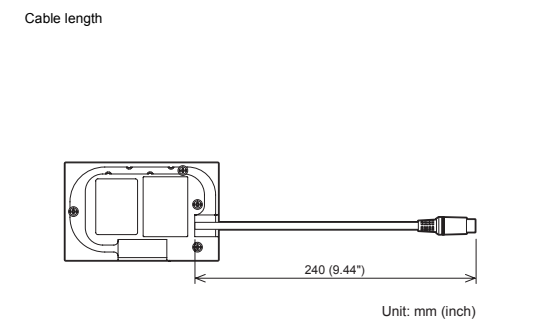

No.	Name	Specifications
1)	POWER LED	LED to show power status
2)	SET/RUN LED	LED to show that the settings are being checked/the transfer is running
3)	ERROR LED	LED to show error status
4)	RD/WR selection switch	Switch to select read/write direction
5)	Data selection switch	Switch to select the data to be transferred
6)	ENT key	Switch to determine the transfer direction and the data to be transferred, and to start the transfer

5. LED lighting specification

LED Name	Status	Contents
POWER	POWER LED is lit.	Power is supplied.
	POWER LED is not lit.	Power is not supplied.
SET/RUN	POWER LED is not lit.	Before starting the transfer.
	Orange light	The transfer direction and the data to be transferred are determined.
	Green flashing	The transfer is running.
	Green light	The transfer is completed.
ERROR	Red flashing	The transfer is aborted.
	POWER LED is not lit.	No errors
	Green light ^{*1}	Write protection switch ON
	Green flashing ^{*1}	The GOT type that is set in the data to be transferred differs from that of the GOT to which the data is transferred.
	Red light ^{*1}	The data to be transferred is broken. The major version of the standard monitor OS is different from that of the project data.
	Red flashing ^{*1}	Communication error occurs between the GOT and the memory loader.
	Red ⇄ Green ^{*1}	Password is set in the project data.
	Orange ⇄ Green ^{*1}	OS installation screen is not active

*1 An error message appears on the GOT screen. Apply remedies according to the display. Refer to the "Chapter 12 Troubleshooting" for details on handling errors.

6. Switch operation specification

Switch Name	Specifications
RD/WR selection switch	Switch to select read/write direction RD : The data is read out from the GOT to the memory loader. WR : The data is written from the memory loader to the GOT.
Data selection switch	Switch to select the data to be transferred • When reading out the data from the GOT to the memory loader [PROJECT + OS] : The standard monitor OS, communication driver, project data, and resource data are read out from the GOT to the memory loader. [PROJECT] : The project data and resource data are read out from the GOT to the memory loader. • When writing the data from the memory loader to the GOT [PROJECT + OS] : The standard monitor OS, font data, communication driver, and project data are written from the memory loader to the GOT. [PROJECT] : The project data is written from the memory loader to the GOT.
Write protection switch	Switch to prevent the memory loader from being written to the data ON : The data cannot be written neither from the GOT or a PC (GT Designer2, GT Designer3) to the memory loader. OFF : The data can be written from the GOT or a PC (GT Designer2, GT Designer3) to the memory loader.
ENT key	Switch to determine the transfer direction and the data to be transferred, and to start the transfer The transfer starts by pressing the key twice. • The first pressing of the key determines the read/write direction and the data to be transferred. (After the read/write direction and the data to be transferred are determined, if RD/WR selection switch and Data selection switch are operated, the operations that have been made will be canceled.) (The ENT key must be pressed within 30 seconds after the first pressing of the ENT key. Failure to do so cancels the operations that have been made.) • The second pressing of the key starts the transfer.

*1 When the standard monitor OS and communication driver are transferred from the memory loader to the GOT, starting up the GOT with OS installation screen is required.

7. Function specification

7.1 Transfer function

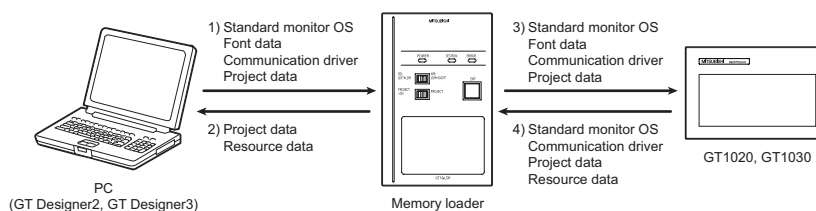

○ : Available to transfer x : Unavailable to transfer

Transfer direction	Data selection switch	Transfer data					Operation
		Project data	Resource data	Standard monitor OS	Font data ²	Communication driver	
1) PC → Memory loader	--	○	x	○	○ ³	○	After all data in the memory loader is deleted, the data selected with GT Designer2 or GT Designer3 is written to the memory loader all at once.
2) Memory loader → PC	--	○	○	x	x	x	The project data or resource data is read out from the memory loader to a PC.
3) Memory loader → GOT	PROJECT + OS	○	x	○	○ ⁴	○	All data in the memory loader is written to the GOT.
	PROJECT	○	x	x	x	x	Only the project data in the memory loader is written to the GOT.
4) GOT → Memory loader	PROJECT + OS ¹	○	○	○	x	○	After all data in the memory loader is deleted, all data in the GOT is read out to the memory loader.
	PROJECT	○	○	x	x	x	After all data in the memory loader is deleted, only the project data and resource data in the GOT are read out to the memory loader.

*1 Ver.01.08.00 or later of the standard monitor OS of the GT10 is applicable.
 *2 Ver.01.11.00 or later of the standard monitor OS of the GT10 is applicable.
 *3 Ver. 2.91V or later of GT Designer2 or Ver. 1.01B or later of GT Designer3 are applicable.

*4 It takes longer time to transfer the font data than to transfer the standard monitor OS and communication driver. (It takes approximately 1 minute and 45 seconds to transfer "Standard monitor OS + Communication driver". It takes approximately 8 minutes to transfer "Standard monitor OS + Communication driver + Font data".) Japanese (supporting Europe) is installed in the GT10 before shipment from the factory. It is not necessary to transfer the font data when the used font is not changed.

7.2 Password reset function on the GOT

When reading out the project data from the memory loader, if the password is set in the project data, password entry screen will appear on the GOT. After entering the password, password is reset by pressing the ENT key on the screen. The data will be transferred from the GOT to the memory loader. The operation procedure is described below.

1) When the upload is started, password entry screen will appear on the GOT. Touch the "INPUT" key.

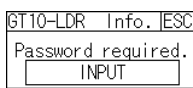

2) After inputting password, touch the "ENT" key.

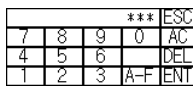

3) When the password matches, a message notifying Password correct is display. Touch the [ESC] button to close the screen.

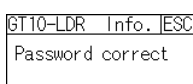

When the password does not match, an error message is displayed. If [OK] button is touch it returns to the password input screen again.

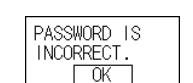

Error message on the GOT

7.3 Error display function

If an error occurs between the GOT and the memory loader during the transfer, an error message will appear on the GOT screen. Apply remedies according to the display.

Chapter 12 Troubleshooting

Turning OFF and ON the power or touching the screen will close the error message screen. When this function is used, Ver.01.08.00 or later of the standard monitor OS of the GT10 is required.

8. Installation of Driver, Setting Software

When the communication between a PC (GT Designer2 Ver.2.77F or later, GT Designer3 Ver.1.01B or later) and the memory loader is performed, driver installation, communication port setting is required.

8.1 Driver installation

When the communication between a PC (GT Designer2, GT Designer3) and the memory loader is performed, driver installation is required. Refer to the following manual for details about driver installation.

GT Designer2 Version □ Basic Operation/Data Transfer Manual
 GT Designer3 Version □ Screen Design Manual (Fundamentals)

8.2 Confirmation of communication port

Windows® XP example follows.

- In Windows® XP, click [Start] → [Settings] → [Control Panel] → [Performance and Maintenance] → [System] → [Hardware] → [Device Manager (D)] and the window below will be displayed. Please confirm the COM number to which the USB driver is allocated (COM and LPT).
- If using Windows® 98, Windows® 98SE, Windows® Millennium Edition or Windows® 2000. A screen that is equivalent to the one below is displayed by clicking [My Computer] → [Control Panel] → [System] → [Device Manager] in the menu of the personal computer.
- If using Windows® Vista. A screen that is equivalent to the one below is displayed by clicking [Start] → [Control Panel] → [Device Manager] in the menu of the personal computer.

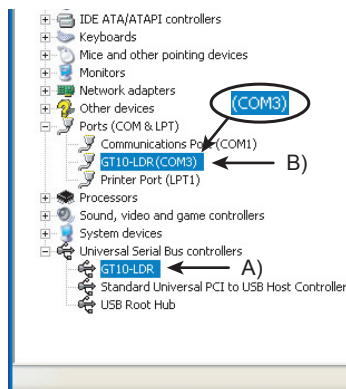

Check following:

- GT10-LDR is indicated at A).
- GT10-LDR (COM *) is indicated at B).
- * indicates the COM number used in Memory loader.
- Install the GT Designer2 or GT Designer3 again when is displayed.

Select the GT Designer2 or GT Designer3 COM number as the COM number currently assigned on the screen above.

8.3 Setting GT Designer2

Click [Communication] → [Communicate with GT10-LDR] → [Communication configuration tab]. Select the same COM number as the COM number of the personal computer when the setting communication port screen appears. Click [Update].

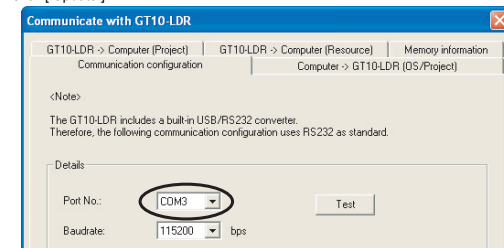

9.2 To read out the data from the memory loader to a PC (GT Designer2 Ver.2.77F or later, GT Designer3 Ver.1.01B or later).

The project data and resource data are read out from the memory loader to a PC (GT Designer2, GT Designer3). The operation procedure is described below.

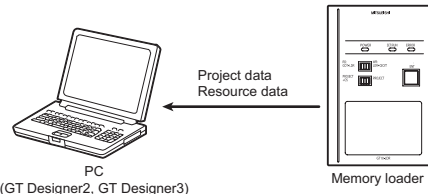

- Connect a PC (GT Designer2, GT Designer3) to the memory loader with USB cable supplied.
- Select the data to be uploaded in a PC (GT Designer2, GT Designer3) and read it out from the memory loader.

Refer to the following manual for details about operating instructions of GT Designer2 or GT Designer3.
 GT Designer2 Version □ Basic Operation/Data Transfer Manual
 GT Designer3 Version □ Screen Design Manual (Fundamentals)

10. To write the data from the Memory loader to the GOT

The standard monitor OS, communication driver, font data, and project data are written from the memory loader to the GOT. The operation procedure is described below.

10.1 When the Data selection switch is [PROJECT + OS]

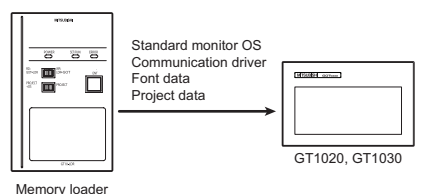

- Connect the memory loader to the GOT.
- Turn ON the GOT by pressing the lower right corner of the GOT. (The GOT startups with OS installation screen.) The OS can be transferred from GT Designer2 Version2 or GT Designer3 Version □ without displaying the OS installation screen depending on the combination of the GOT and the standard monitor OS. Refer to the following manual for details about OS installation screen.
 GT 10 User's Manual

- Set the Data selection switch to [PROJECT + OS] and the RD/WR selection switch to [WR], and select the data to be transferred and transfer direction.
- Press the ENT key to determine the data to be transferred and transfer direction. (SET/RUN LED will be orange.)
 *: If the next operation is not performed within 30 seconds after the ENT key is pressed, SET/RUN LED will be unit, and the operations that have been made will be canceled.
 *: When the Data selection switch or the RD/WR selection switch is operated, after the data to be transferred and the transfer direction are determined, the operations that have been made will be canceled.
- Press the ENT key again to start the transfer. (SET/RUN LED will be green flashing.)
- Turn OFF the GOT and remove the memory loader after the transfer is completed. (SET/RUN LED will be green flashing.)

Refer to the "Chapter 12 Troubleshooting" for details on handling errors during transferring.

10.2 When the Data selection switch is [PROJECT]

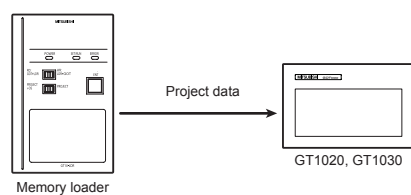

- Connect the memory loader to the GOT and turn ON the GOT.
- Set the Data selection switch to [PROJECT] and the RD/WR selection switch to [WR], and select the data to be transferred and transfer direction.
- Press the ENT key to determine the data to be transferred and transfer direction. (SET/RUN LED will be orange.)
 *: If the next operation is not performed within 30 seconds after the ENT key is pressed, SET/RUN LED will be unit, and the operations that have been made will be canceled.
 *: When the Data selection switch or the RD/WR selection switch is operated, after the data to be transferred and the transfer direction are determined, the operations that have been made will be canceled.
- Press the ENT key again to start the transfer. (SET/RUN LED will be green flashing.)
- Turn OFF the GOT and remove the memory loader after the transfer is completed. (SET/RUN LED will be green flashing.)

Refer to the "Chapter 12 Troubleshooting" for details on handling errors during transferring.

11. To read out the data from the GOT to the Memory loader

The standard monitor OS, communication driver, project data, and resource data are read out from the GOT to the memory loader. The operation procedure is described below.

11.1 When the Data selection switch is [PROJECT + OS]

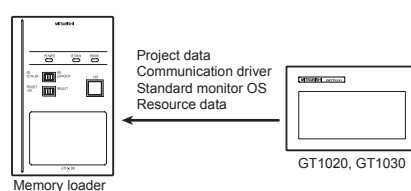

- Turn OFF the Write protection switch.
- Connect the memory loader to the GOT and turn ON the GOT.
- Set the Data selection switch to [PROJECT + OS] and the RD/WR selection switch to [RD], and select the data to be transferred and transfer direction.
- Press the ENT key to determine the data to be transferred and transfer direction. (SET/RUN LED will be orange.)
 *: If the next operation is not performed within 30 seconds after the ENT key is pressed, SET/RUN LED will be unit, and the operations that have been made will be canceled.
 *: When the Data selection switch or the RD/WR selection switch is operated, after the data to be transferred and the transfer direction are determined, the operations that have been made will be canceled.
- Press the ENT key again to start the transfer. (SET/RUN LED will be green flashing.)
- Turn OFF the GOT and remove the memory loader after the transfer is completed. (SET/RUN LED will be green flashing.)

Refer to the "Chapter 12 Troubleshooting" for details on handling errors during transferring.

11.2 When the Data selection switch is [PROJECT]

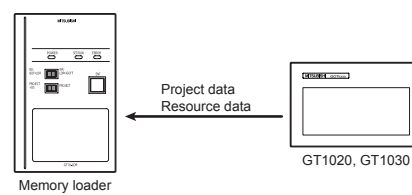

- Turn OFF the Write protection switch.
- Connect the memory loader to the GOT and turn ON the GOT.
- Set the Data selection switch to [PROJECT] and the RD/WR selection switch to [RD], and select the data to be transferred and transfer direction.
- Press the ENT key to determine the data to be transferred and transfer direction. (SET/RUN LED will be orange.)
 *: If the next operation is not performed within 30 seconds after the ENT key is pressed, SET/RUN LED will be unit, and the operations that have been made will be canceled.
 *: When the Data selection switch or the RD/WR selection switch is operated, after the data to be transferred and the transfer direction are determined, the operations that have been made will be canceled.
- Press the ENT key again to start the transfer. (SET/RUN LED will be green flashing.)
- Turn OFF the GOT and remove the memory loader after the transfer is completed. (SET/RUN LED will be green flashing.)

Refer to the "Chapter 12 Troubleshooting" for details on handling errors during transferring.

12. Troubleshooting

12.1 GOT error message

When communication between the GOT and the memory loader does not work, check the following contents depending on the GOT error messages.

GOT error message	Remedy
Write protection switch is ON	Write protection switch ON Turn OFF the Write protection switch.
Wrong GOT model is connected	The GOT type that is set in the data to be transferred differs from that of the GOT to which the memory loader is connected.
Corrupt data or OS version variance	The data to be transferred is broken, or the major version of the standard monitor OS is different from that of the project data. • Write the standard monitor OS, communication driver, and project data from GT Designer2 or GT Designer3 to the memory loader again, and then transfer them to the GOT again. • Set the Data selection switch to [PROJECT + OS] and read out all data from the GOT to the memory loader, and then transfer them to the GOT again.
Communication error	Communication error occurs between the GOT and the memory loader. • Check the connection with the communication cable. • Check that power supply is stable. (lighting of POWER LED)
GOT contains a system password	Password is set in the project data. Reset the password with the numeric keypad on the GOT.
OS installation screen isn't active	OS installation screen is not active Install the data after the OS installation screen is displayed on the GOT.

8.4 Setting GT Designer3

Click [Communication] → [Communicate with GT10-LDR...] to display the communication configuration dialog. Click the [Communication Configuration...] tab to display the communication configuration dialog. Select the same COM number as the COM number of the personal computer when the setting communication port screen appears. Click [OK].

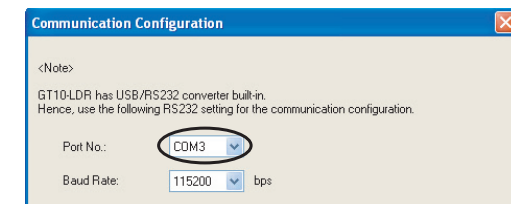

9. Transfer procedures between a PC and the Memory loader

9.1 To write the data from a PC (GT Designer2 Ver.2.77F or later, GT Designer3 Ver.1.01B or later) to the memory loader

The standard monitor OS, communication driver, font data, and project data are written from a PC (GT Designer2, GT Designer3) to the memory loader. The operation procedure is described below.

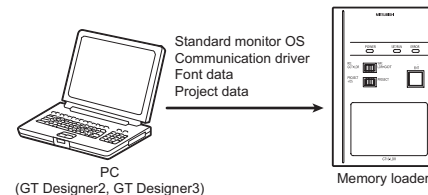

- Turn OFF the Write protection switch.
- Connect a PC (GT Designer2, GT Designer3) to the memory loader with USB cable supplied.
- Write the data from a PC (GT Designer2, GT Designer3) to the memory loader.

Refer to the following manual for details about operating instructions of GT Designer2 or GT Designer3.
 GT Designer2 Version □ Basic Operation/Data Transfer Manual
 GT Designer3 Version □ Screen Design Manual (Fundamentals)

12.2 LED display on the memory loader

If communication cannot be established between the GOT and a PC using memory loader, confirm the following status by checking display LED in memory loader.

State of POWER LED	Contents
POWER LED is lit.	The DC5V power supply from the GOT or the personal computer is normally supplied. In case of no communication, check the status of ERROR LED.
POWER LED is not lit.	The DC 5V power supply from the GOT or the personal computer is not supplied. Check the items below. • Turn ON the power. • Check the connection with the USB cable. • Check the connection with the GOT. • Check that PLC is not overloaded when PLC supplies the power to the GOT connected to the memory loader.
State of ERROR LED	Contents
Green light	Write protection switch ON Turn OFF the Write protection switch.
Green flashing	The GOT type that is set in the data to be transferred differs from that of the GOT to which the data is transferred. Check the GOT type to which the memory loader is connected.
Red light	The data to be transferred is broken, or the major version of the standard monitor OS is different from that of the project data. • Write the standard monitor OS, communication driver, and project data from GT Designer2 or GT Designer3 to the memory loader again, and then transfer them to the GOT again. • Set the Data selection switch to [PROJECT + OS] and read out all data from the GOT to the memory loader, and then transfer them to the GOT again.
Red flashing	Communication error occurs between the GOT and the memory loader. • Check the connection with the communication cable. • Check that power supply is stable. (lighting of POWER LED)
Red ↔ Green	Password is set in the project data. Reset the password with the numeric keypad on the GOT.
Orange ↔ Green	OS installation screen is not active Install the data after the OS installation screen is displayed on the GOT.

This manual confers no industrial property rights or any rights of any other kind, nor does it confer any patent licenses. Mitsubishi Electric Corporation cannot be held responsible for any problems involving industrial property rights which may occur as a result of using the contents noted in this manual.

Warranty
 Mitsubishi will not be held liable for damage caused by factors found not to be the cause of Mitsubishi; opportunity loss or lost profits caused by faults in the Mitsubishi products; damage, secondary damage, accident compensation caused by special factors unpredictable by Mitsubishi; damages to products other than Mitsubishi products; and to other duties.

For safe use

- This product has been manufactured as a general-purpose part for general industries, and has not been designed or manufactured to be incorporated in a device or system used in purposes related to human life.
- Before using the product for special purposes such as nuclear power, electric power, aerospace, medicine or passenger movement vehicles, consult with Mitsubishi Electric.
- This product has been manufactured under strict quality control. However when installing the product where major accidents or losses could occur if the product fails, install appropriate backup or failsafe functions in the system.